



ELIZABETH

A-LINE SERIES
Model BL200A

*Quick
Reference
Guide*



FOR THE LOVE OF SEWING

To register your machine warranty and receive Baby Lock product updates and offers, go to www.babylock.com/profile. If you have questions with registration, visit your Authorized Baby Lock Retailer.

Baby Lock Consumer Helpline: 800-313-4110
www.babylock.com

Refer to the instruction manual for detailed instructions.

Reportez-vous au manuel d'instructions pour des informations détaillées.

Consulte el manual de instrucciones para obtener información detallada.

Contents

Table des matières

Contenido



Bobbin winding and setting

2

Bobinage et réglage de la canette
Colocación y devanado de la bobina



Upper threading

4

Enfilage supérieur
Enhebrado del hilo superior



Selecting stitch patterns

6

Sélection des motifs de point
Selección de patrones de costura



Combining and saving patterns

10

Combinaison et enregistrement de motifs
Combinación y almacenamiento de patrones



Saved patterns' memo

11

Mémo des motifs enregistrés
Memoria de patrones guardados

Summary of stitch patterns

12

Résumé des motifs de point
Resumen de patrones de costura

Preset utility stitch/Utility stitches 12

Préréglage de point de couture courant/
Points de couture courants

Costura con aplicaciones preajustada/
Puntadas con aplicaciones

Decorative stitches/ Utility decorative stitches 13

Points décoratifs/Points décoratifs courants
Puntadas decorativas/
Puntadas decorativas utilitarias

Character stitches (Gothic font/Script font) 14

Points caractères
(police Gothic/police Script)
Puntadas de caracteres
(escritura gótica/escritura decorada)

Character stitches (Outline style) 15

Points caractères (style Contours)
Puntadas de caracteres (escritura con borde)

Bobbin winding and setting

Bobinage et réglage de la canette
Colocación y devanado de la bobina



Use only the included bobbin or bobbins of the same type.

N'utilisez que la canette fournie ou une canette du même type.

Utilice sólo la bobina suministrada o bobinas del mismo tipo.

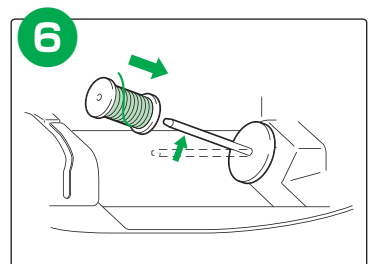
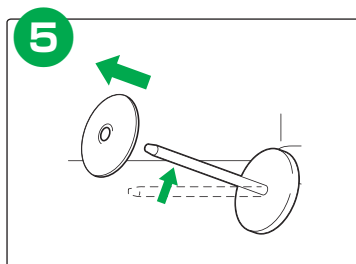
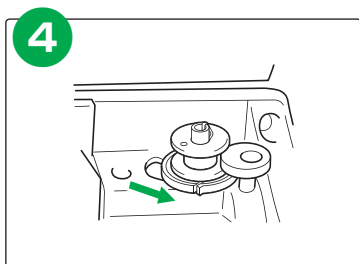
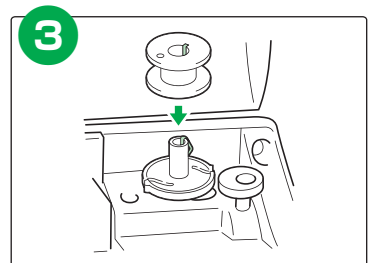
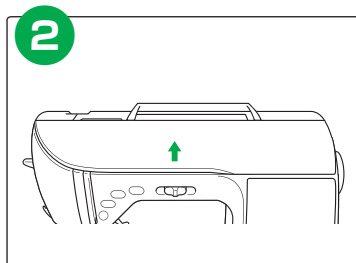
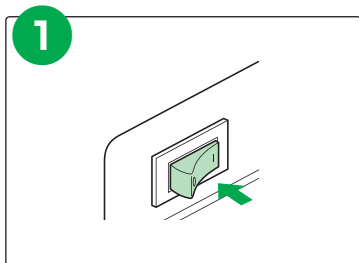
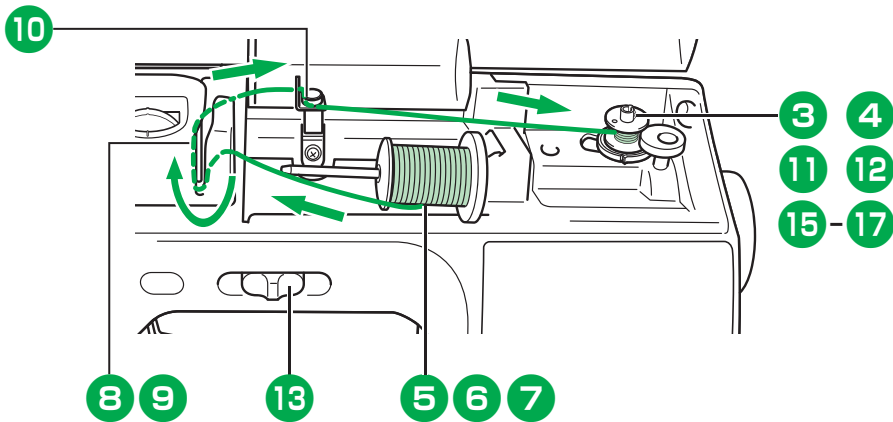
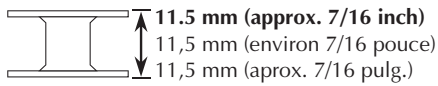

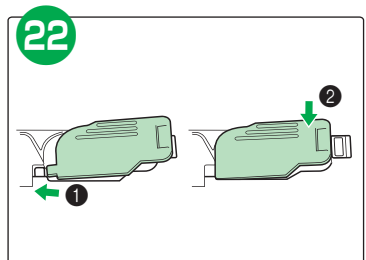
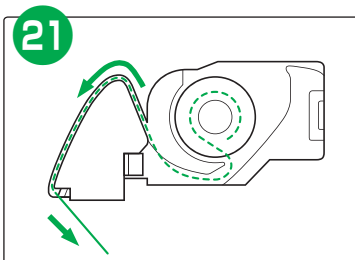
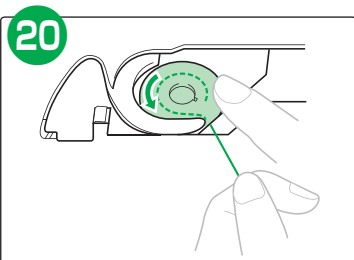
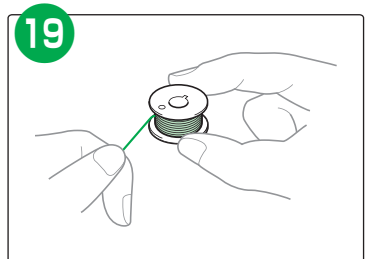
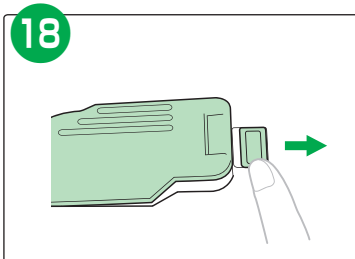
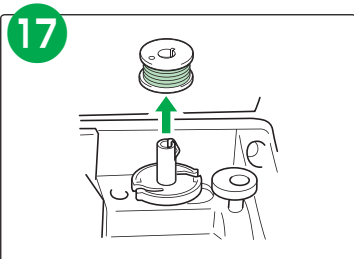
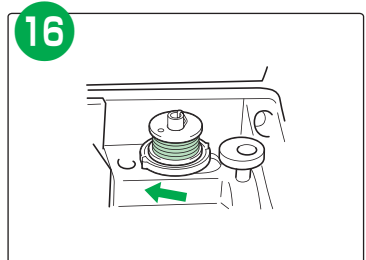
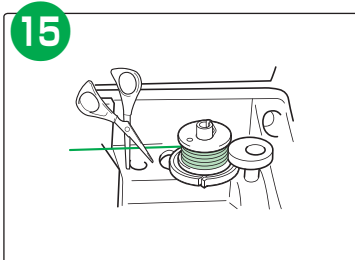
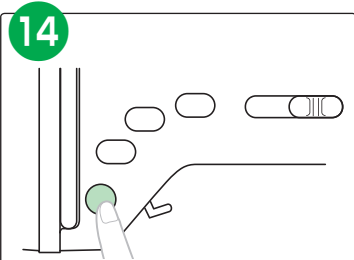
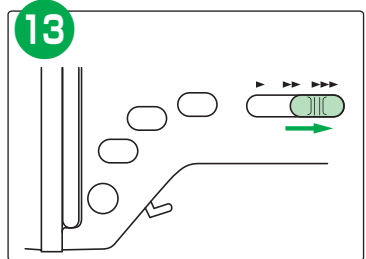
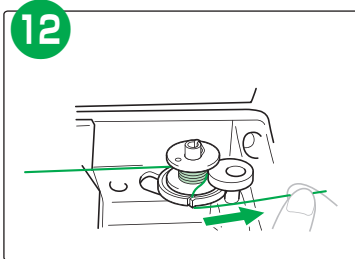
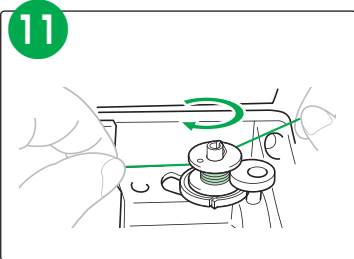
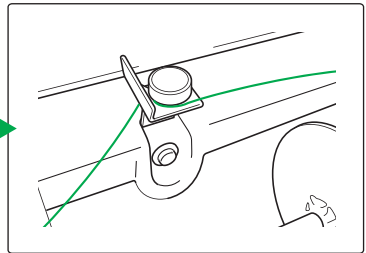
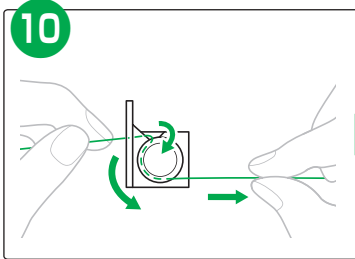
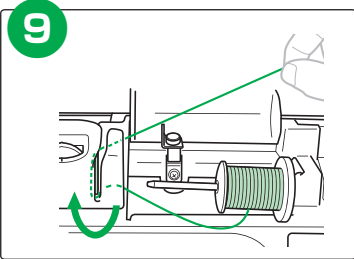
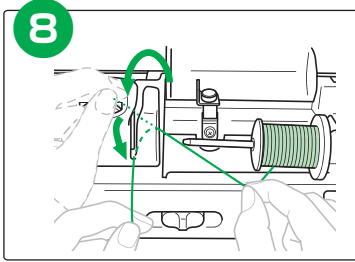
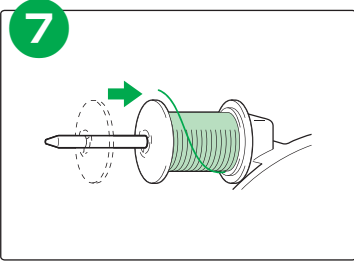
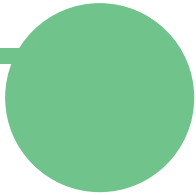

Upper threading

Enfilage supérieur

Enhebrado del hilo superior

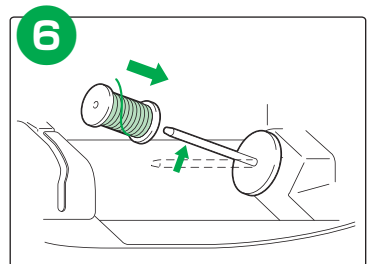
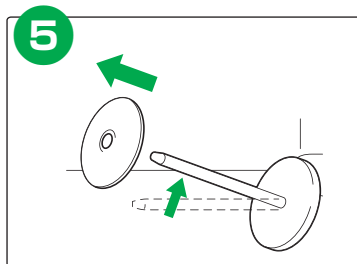
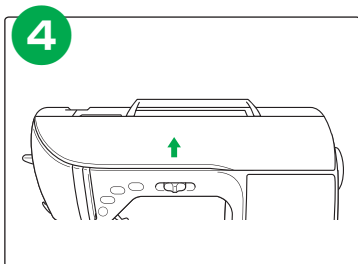
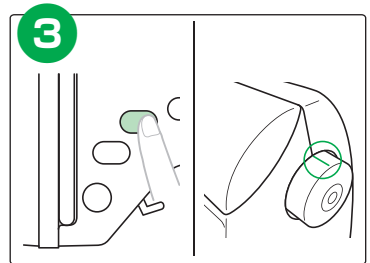
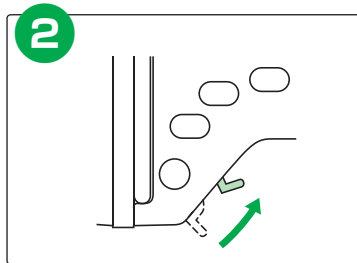
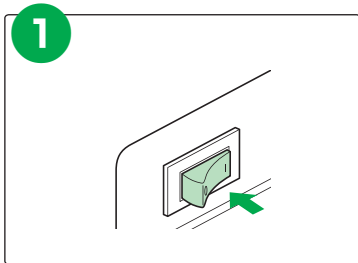
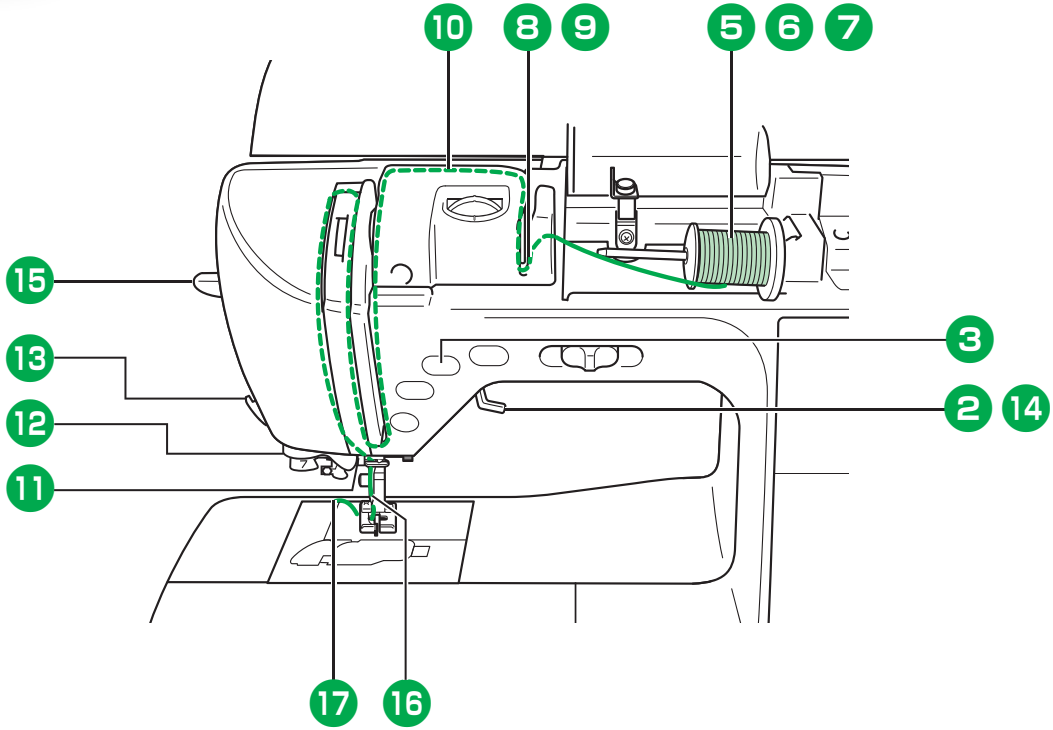

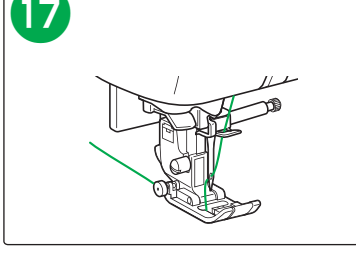
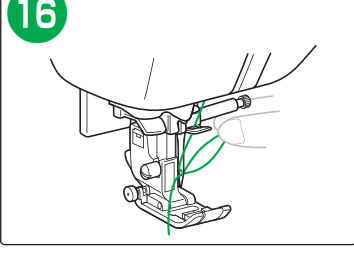
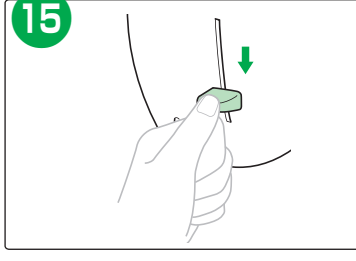
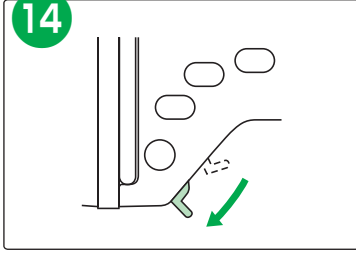
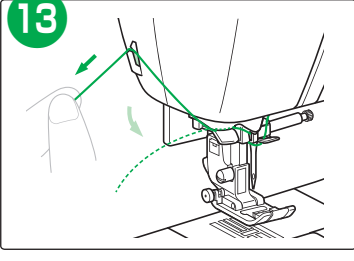
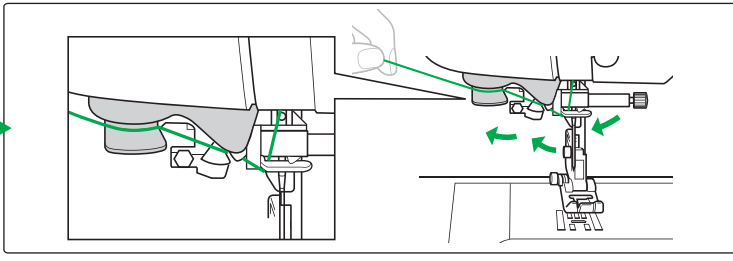
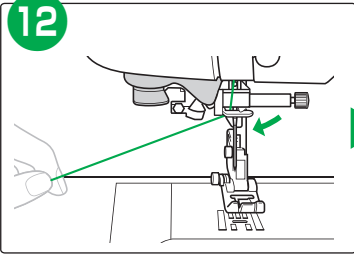
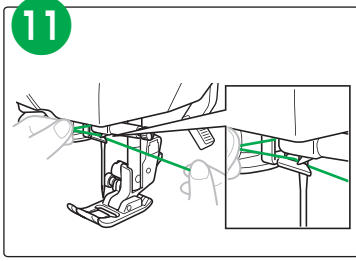
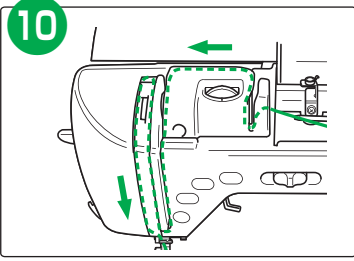
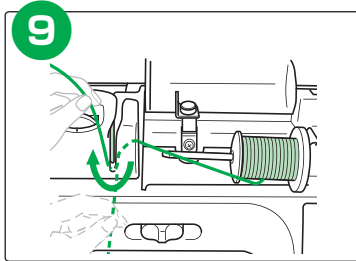
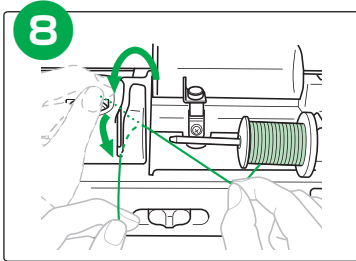
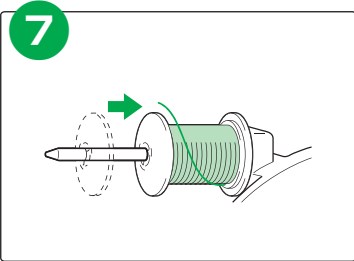
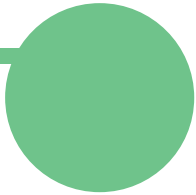

Selecting stitch patterns

Sélection des motifs de point

Selección de patrones de costura

Preset utility stitch/ saved pattern key

Touche de pré réglage
de point de couture
courant/motif enregistré

Tecla de costura con
aplicaciones preajustada/
costura guardada

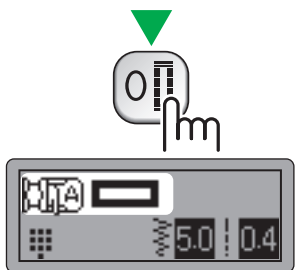
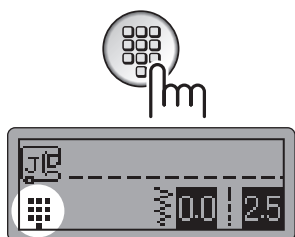
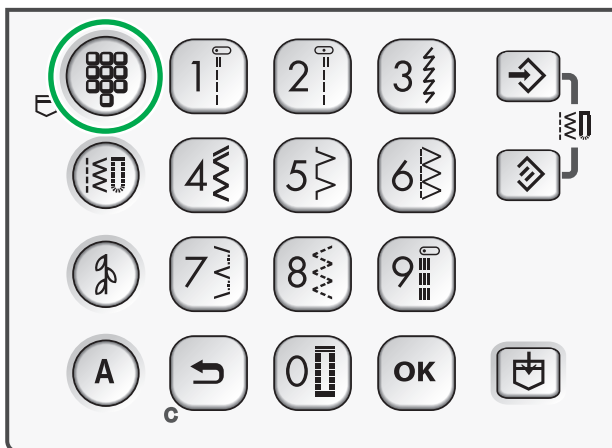

See page 12.
Reportez-vous à la page 12.
Consulte la página 12.

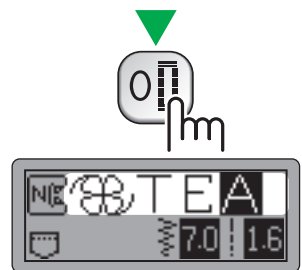
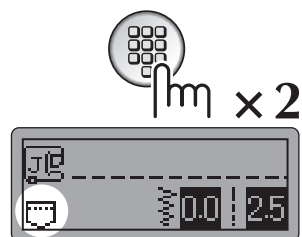

See page 11.
Reportez-vous à la page 11.
Consulte la página 11.





Utility stitches
Points de couture courants
Puntadas con aplicaciones

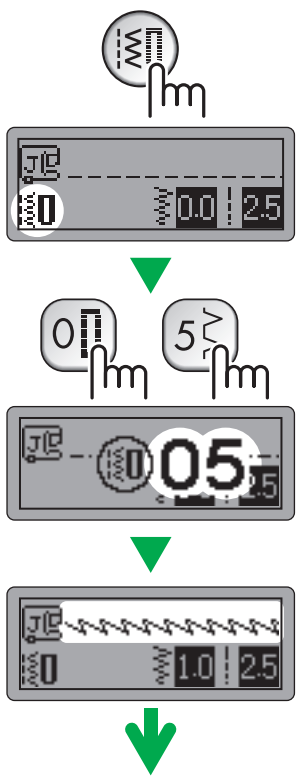

See page 12.
Reportez-vous à la page 12.
Consulte la página 12.

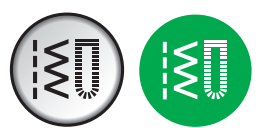



Decorative stitches

Points décoratifs

Puntadas decorativas

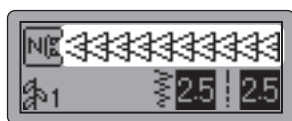
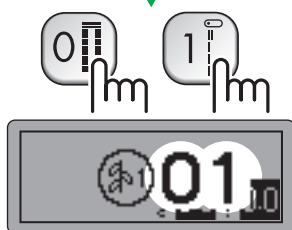
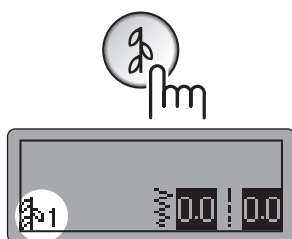

See page 13.
Reportez-vous à la page 13.
Consulte la página 13.

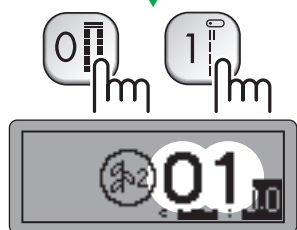
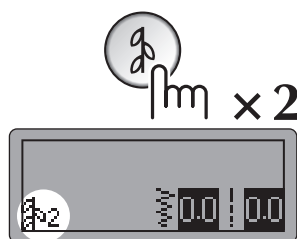

See page 13.
Reportez-vous à la page 13.
Consulte la página 13.



A

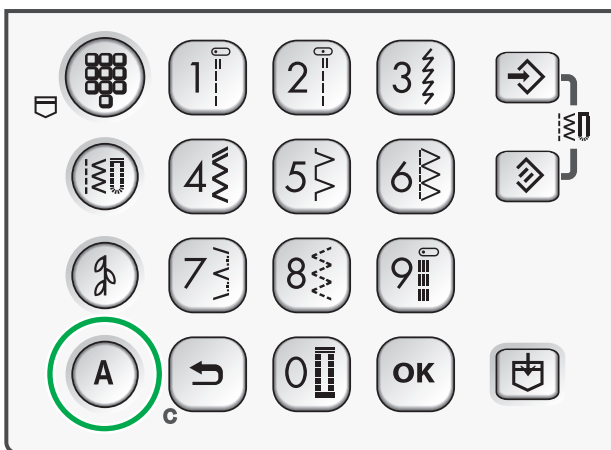

Character stitches
Points caractères
Puntadas de caracteres

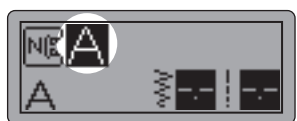
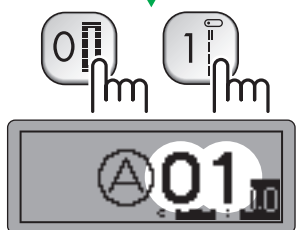
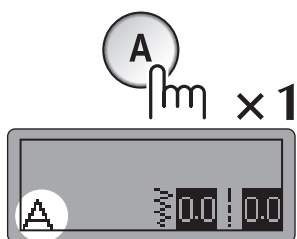

See page 14.
Reportez-vous à la page 14.
Consulte la página 14.

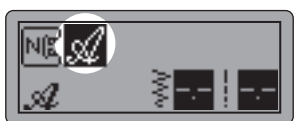
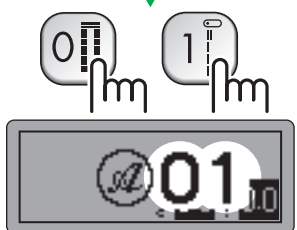
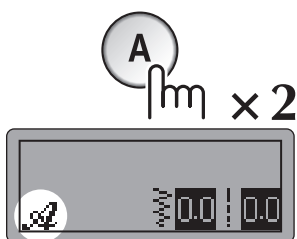

See page 14.
Reportez-vous à la page 14.
Consulte la página 14.

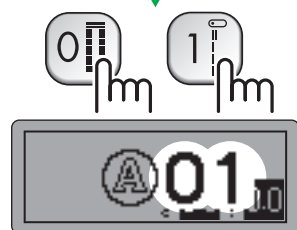
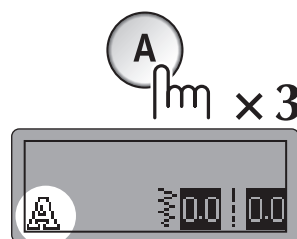

See page 15.
Reportez-vous à la page 15.
Consulte la página 15.





Combining and saving patterns

Combinaison et enregistrement de motifs
Combinación y almacenamiento de patrones

Example: Exemple/ Ejemplo:
☘ TEA

Combining patterns Combinaison de motifs/ Combinación de patrones

1

2

3

4

Saving patterns Enregistrement des motifs/ Almacenamiento de patrones

5

6

7

Saved patterns' memo

Mémo des motifs enregistrés
Memoria de patrones guardados



Saved patterns Motifs enregistrés/ Patrones guardados

1	
2	
3	
4	
5	
6	
7	
8	
9	
0	

Summary of stitch patterns

Résumé des motifs de point
Resumen de patrones de costura



Preset utility stitch Préréglage de point de couture courant/ Costura con aplicaciones preajustada

1	2	3	4	5	6	7	8	9	0



Utility stitches Points de couture courants/ Puntadas con aplicaciones

00	0	1	2	3	4	5	6	7	8	9
0	01	02	03	04	05	06	07	08	09	
1	10	11	12	13	14	15	16	17	18	19
2	20	21	22	23	24	25	26	27	28	29
3	30	31	32	33	34	35	36	37	38	39
4	40	41	42	43	44	45	46	47	48	49
5	50	51	52	53	54	55	56	57	58	59
6	60	61	62	63	64	65	66	67		



1

Decorative stitches Points décoratifs/ Puntadas decorativas

00	0	1	2	3	4	5	6	7	8	9
0		01	02	03	04	05	06	07	08	09
1	10	11	12	13	14	15	16	17	18	19
2	20	21	22	23	24	25	26	27	28	29
3	30	31	32	33	34	35	36	37	38	39
4	40	41	42	43	44	45	46	47	48	49
5	50	51	52	53	54	55	56	57	58	59
6	60	61	62	63	64	65	66	67	68	69
7	70	71	72							



2

Utility decorative stitches Points décoratifs courants/ Puntadas decorativas utilitarias

00	0	1	2	3	4	5	6	7	8	9
0		01	02	03	04	05	06	07	08	09
1	10	11	12	13	14	15	16	17	18	19
2	20	21	22	23	24	25	26	27	28	29
3	30	31	32	33	34	35	36	37	38	39

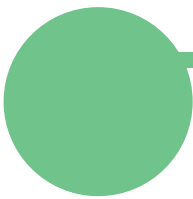

A **A** **Character stitches (Gothic font)**

Points caractères (police Gothic)/ Puntadas de caracteres (escritura gótica)

00	0	1	2	3	4	5	6	7	8	9
0	/	01 A	02 B	03 C	04 D	05 E	06 F	07 G	08 H	09 I
1	10 J	11 K	12 L	13 M	14 N	15 O	16 P	17 Q	18 R	19 S
2	20 T	21 U	22 V	23 W	24 X	25 Y	26 Z	27 &	28 ?	29 !
3	30 -	31 0	32 1	33 2	34 3	35 4	36 5	37 6	38 7	39 8
4	40 9	41 ' ,	42 ,	43 .	44 ()	45 -	46 -	47 Ä	48 Å	49 Æ
5	50 Ñ	51 Ö	52 Ø	53 Ç	54 Ü	55 ß				

A **A** **Character stitches (Script font)**

Points caractères (police Script)/ Puntadas de caracteres (escritura decorada)

00	0	1	2	3	4	5	6	7	8	9
0	/	01 A	02 B	03 C	04 D	05 E	06 F	07 G	08 H	09 I
1	10 J	11 K	12 L	13 M	14 N	15 O	16 P	17 Q	18 R	19 S
2	20 T	21 U	22 V	23 W	24 X	25 Y	26 Z	27 &	28 ?	29 !
3	30 -	31 0	32 1	33 2	34 3	35 4	36 5	37 6	38 7	39 8
4	40 9	41 ' ,	42 ,	43 .	44 ()	45 -	46 -	47 A	48 A	49 B
5	50 N	51 O	52 O	53 C	54 U	55 B				

A



Character stitches (Outline style)

Points caractères (style Contours)/ Puntadas de caracteres (escritura con borde)

	01 A	02 B	03 C	04 D	05 E	06 F	07 G	08 H	09 I	
	10 J	11 K	12 L	13 M	14 N	15 O	16 P	17 Q	18 R	19 S
	20 T	21 U	22 V	23 W	24 X	25 Y	26 Z	27 &	28 ?	29 !
	30 _	31 0	32 1	33 2	34 3	35 4	36 5	37 6	38 7	39 8
	40 9	41 ' ,	42 ' ,	43 .	44 ()	45 -	46 Ä	47 Å	48 Æ	
	50 Ñ	51 Ö	52 Ø	53 Ç	54 Ü	55 ß				

